

BIGBOOK

SECURITY
BUSINESS
The Path to Greater Profits for Security Integrators

SECURITY
TECHNOLOGY EXECUTIVE

LOCKSMITH LEDGER
International

THE SECURITY INDUSTRY'S PRODUCT GUIDE • SPRING 2022



Theia Technologies' Award-Winning 4K Lens Family

Theia's family of 4K lenses provides full 12 megapixel 300 lp/mm resolution performance for the most demanding applications such as ANPR/LPR, traffic monitoring and analytics.

Two lenses cover a horizontal field of view of 7 to 112 degrees, with the SL/TL410 lens providing a 4-10mm focal range, while the SL/TL1250 telephoto lens offers a 12-50mm focal range. Both have excellent IR correction with less than a 5µ focus shift in Near IR light for superior Day/Night performance. At f/1.4 the SL/TL410 lens offers excellent light gathering ability in low light conditions. The lenses are designed to cover the larger 1/1.7" 4K image sensors while at the same time resolving the smaller 1.55µ pixels of the 1/2.3" 4K sensors.

Measuring only 52mm long (64.5mm TTL) they are the most compact of comparable 1/1.7" format 4K lenses available on the market to facilitate use in domes, bullets, small enclosures, as well as on box cameras. Both lenses feature a slip ring mount that allows the user to position thumb screws for convenient access to focus and focal length adjustments post-installation on the camera.

The lenses are offered in manual, DC Auto, or Precise iris versions, and CS or C mount depending on the model.

For full specifications, drawings and CAD files, visit the links below, or email info@theiatech.com for pricing and availability.

www.theiatech.com/4k-resolution-lenses

Theia
TECHNOLOGIES

Request more information: www.securityinfowatch.com/12399899

STid Architect Blue Readers

STid's Architect® Blue series includes seven interchangeable modules that can be connected easily to a smart RFID and Bluetooth core. Intuitive and dynamic, it offers a variety of form factors (mullion, gang box) and features (card reader, keypad, touchscreen, biometrics, QR Code, 125 kHz) for optimal performance in a wide variety of client applications with all functionality and security levels easily upgraded.



With a patented tamper protection system, Architect Blue readers protect sensitive data and enable easy deletion of authentication keys, when necessary. They have been designed to withstand harsh environments and high impact, and to operate well outside. The multi-technology RFID, NFC and Bluetooth® readers can be equipped with a biometric fingerprint sensor for enhanced security; making Architect Blue the industry's first OSDP™-certified biometric reader. It combines strong 1:1 authentication with fingerprint, card and Bluetooth® smartphone technologies.

STid Group, a leading manufacturer of next-generation contactless high security, has the widest range of OSDP-certified readers on the market today. Additionally, STid offers the first OSDP-certified touchscreen readers with scramble keypad function. Architect Blue is one of the only readers to support OSDP File Transfer to update a system's access control readers remotely. No more time-consuming configuring individual readers on location with configuration cards.

<https://stid-security.com>

STid

Request more information: www.securityinfowatch.com/21239240



SDC S5000 Storefront Exit Device with Latch Retraction

SDC's S5000 is a heavy-duty, code-compliant alternative to magnetic locks for storefront applications that require durability, superior aesthetics and smooth operation. This UL305 panic-rated exit device is American-made, featuring all-metal construction that is particularly suited to aluminum glass entrances for both manual and automated door openings and new or retrofit applications.

Not only does the SDC S5000 meet the market need for a Storefront Exit Device with Electric Latch Retraction standard, it also comes with optional Request-to-Exit monitoring for access control compatibility. The S5000 with factory installed motorized electric latch retraction makes application as easy as Install - Power - Done.

- Factory Installed Motorized Electric Latch Retraction
- Request-To-Exit (REX) Monitoring - optional
- Electric Dogging to Hold Latch Retracted
- Storefront Aesthetics & Smooth Operation
- Compatible with Low-Energy Door Operators
- UL305 Panic-Rated, Grade 1
- Latch Status Optional
- Rim & Concealed Vertical Rod Devices
- Aluminum Glass Door Applications
- American Made

SDC
Security Door Controls

www.sdcsecurity.com/S5000

Request more information: www.securityinfowatch.com/21220935

Medeco Intelligent Key Cabinet

The Intelligent Key Cabinet (IKC) from Medeco securely stores, distributes, and tracks every key so your facility is never at risk.

IKC is an electronically controlled key management system that increases accountability and efficiency, and essentially eliminates the risk of misplaced keys.

- **Increase Efficiency:** Authorized personnel can "self-serve"/retrieve keys without an administrator by accessing keys via biometric fingerprint, PIN, and/or Prox Card. The built-in LCD screen guides authorized personnel through the entire process.
- **Increase Oversight:** Know who has keys, which keys they have, and when keys are returned.
- **Increase Awareness:** Alerts for unreturned keys ensure keys never leave the facility without an audit trail, limiting exposure to loss or theft.
- **Increase Security:** Multiple-factor authentication available to access the cabinet. The IKC comes with a built-in camera for security photo capture.
- **Increase Intelligence:** Identify potential problems in key removal and return before they escalate. A complete reporting suite and real-time data shows trends in activity.
- **Increase Your Options:** Multiple configurations available for different types of keys or assets. When combined with the Medeco XT Intelligent Key System of electronic locks, the XT configuration allows you to see which openings were accessed and when.



medeco
ASSA ABLOY

<http://Medeco.com/IKC>

Request more information: www.securityinfowatch.com/21239240

INNOVATIVE DESIGNS SUPERIOR PRODUCTS

THE RIM PANIC SOLUTIONS



**THE
NEW
ENHANCED
4850**



**NOW EVERYDAY
LOW CURRENT DRAW**

**UP TO 48% LOWER
THAN THE COMPETITION**

**SEARCH "NEW TRINE 4850"
TO LEARN MORE**

AVAILABLE JULY

Request information: www.SecurityInfoWatch.com/10215438

**THE SUPERIOR
4800F**

**FIRE RATED LIKE A
9500, PRICED
LIKE A 9600.**



TRINE
ACCESS TECHNOLOGY®

See it at ESX Texas
NAPCO Booth 301



Access Control RMR Made Easy

Get Hosted Accounts & RMR Faster than Ever with
1st Cell-Based Access Control System, **\$19⁹⁵/mo./per System**



AirAccess offers a profitable new hosted business model for creating new commercial accounts faster and adding new RMR twice as quickly, providing ACaaS, Access Control as a Service and real-time access & emergency monitoring. Using effortless StarLink cellular-networking, AirAccess automatically works around the customer's network or IT Dept

(or lack thereof), and is flexibly wireless, from your choice of doors to the cloud. Under \$20/mo per System (not per door), you can outbid the competition, offering accounts 24/7 monitored security and the convenience of Free Remote App with built-in mobile credential, SMS alerts & lockdown— without their investing in server hardware, updates or onsite security staff.

- Easy Cell- & Cloud-Based Access Control as a Service (ACaaS) – Flexible Options for Dealers/Integrators &/or Locksmiths @ Flat Monthly System Rate
- No IT Dept or ISP/Network Changes – Powered by StarLink Cellular, it automatically makes network-connections for you
- Up to 2x RMR-earnings w/ Real-Time Access &/or Emergency Monitoring option to any Central Station
- Add Choice of Wireless Doors – Wireless Panels w/ Wiegand Readers or Gate Systems/Operators or Alarm Lock Wireless PIN/Prox Trilogy Locks or Designer ArchiTech Series
- Right-Sized & Affordable for SMBs, offices, retail, multi-tenant, gated communities &/or office parks
- FREE Remote App w/ Built-in Mobile Credentials, SMS-alerts, Lockdown & door control
- AirAccess Starter Kits – Ready-to-connect hundreds of doors & users out-of-the-box; including AirAccess Cloud-Based Software w/ 5-Step Wizard.
2 kits #AA-LTEA or AA-LTEA-PW (w/Power)



NAPCO **Access** Ask for AirAccess at Security, Locking or Access Solutions Distributors
or call at 1.800.645.9445 • For More visit www.AirAccess.com

AirAccess, StarLink, Trilogy, Network are trademarks of NAPCO Security Technologies. Monthly Flat System Base Rate of \$19.95 in US Dollars; +\$5.95 for CS alarm monitoring option.

Request information: www.SecurityInfoWatch.com/10215125



BIGBOOK

THE SECURITY INDUSTRY'S PRODUCT GUIDE

SPRING 2022



B6 Access Control & Door Hardware



B12 Installation Tools



B12 Perimeter Security



B14 Video Surveillance



B16 Power Supplies



B18 Communications

Advertiser Name	Page	WebSite URL
Altronix Corporation	B15	www.securityinfowatch.com/10212790
Banner Solutions	B17	www.securityinfowatch.com/12071932
Camden Door Controls	B18	www.securityinfowatch.com/10213140
Command Access	B11	www.securityinfowatch.com/12140374
Detex Corporation	B4	www.securityinfowatch.com/10213445
DKS DoorKing Systems	B7	www.securityinfowatch.com/10213482
IDN Inc.	B13	www.securityinfowatch.com/11291392
Medeco High Security Locks	B5	www.securityinfowatch.com/10214355
NAPCO Security Technologies	B3	www.securityinfowatch.com/10215125
SALTO Systems Inc	B9	www.securityinfowatch.com/10225529
SDC-Security Door Controls	B19	www.securityinfowatch.com/10214991
Seclock	B20	www.securityinfowatch.com/10215009
STI-Safety Technology Int'l	B14	www.securityinfowatch.com/10214881
Trine Access	B2	www.securityinfowatch.com/10215438
Viking Electronics	B16	www.securityinfowatch.com/10556843

This index is supplied as a service to our readers. The publisher assumes no liability for omissions or errors.

PUBLISHED BY



1233 Janesville Ave
Fort Atkinson WI 53538
920-563-6388; 800-547-7377

THE BIG BOOK

is a supplement to *Locksmith Ledger*, *Security Business* and *Security Technology Executive* magazines.

EDITORIAL

Editor, The Big Book | Paul Rothman
1233 Janesville Avenue
Fort Atkinson, WI 53538
(847) 454-2731
prothman@securitybusinessmag.com

Editorial Director | Steve Lasky
(847) 454-2719
steveo@securityinfowatch.com

Editor, Locksmith Ledger | Will Christensen
Editor, Security Business | Paul Rothman
Editor, Security Technology Executive | Steve Lasky
Editor, SecurityInfoWatch.com | Joel Griffin

SALES

Group Publisher | Nancy Levenson-Brokamp
(847) 454-2702
nancy@securityinfowatch.com

Northeast US & Eastern Canada | Janice Welch
(224) 324-8508
janice@securityinfowatch.com

Midwest | Brian Lowy
(847) 454-2724
brlowy@endeavorb2b.com

Western US & Western Canada | Bobbie Ferraro
(310) 800-5252
bobbie@securityinfowatch.com

PRODUCTION

Production Manager | Jane Pothlanski
jpothlanski@endeavorb2b.com

Ad Services Manager | Carmen Seeber
cseeber@endeavorb2b.com

Art Director | Eric Van Egeren
evanegeren@endeavorb2b.com

Audience Development Manager | Delicia Poole
dpoole@endeavorb2b.com

ENDEAVOR BUSINESS MEDIA, LLC

Chief Executive Officer | Chris Ferrell
Chief Revenue Officer/CMO | June Griffin
Chief Operations Officer | Patrick Raines
Chief Administrative and Legal Officer | Tracy Kane
EVP/Group Publisher | Lester Craft
EVP Special Projects | Kristine Russell
EVP Marketing Solutions | Jacquie Niemiec
VP Accounting | Angela Mitchell
VP Content | Travis Hessman
VP Digital Business Development | Monique Leija
VP Finance | Jessica Klug
VP Production Operations | Curt Pordes
VP Technology | Glenn Scheithauer

Subscription Customer Service

PO Box 3257, Northbrook, IL 60065-3257
Toll-Free 877-382-9187; Local 847-559-7598
Circ.SecDealer@omeda.com

Article Reprints

To purchase article reprints, please email
reprints@endeavorb2b.com.

List Rental | InfoGroup

Michael Costantino | (402) 836-6266
Michael.Costantino@infogroup.com
Kevin Collopy | (402) 836-6265
Kevin.Collopy@infogroup.com

Printed in the USA. Copyright 2022 Endeavor Business Media, LLC. All rights reserved. No part of this publication may be reproduced or transmitted in any form or by any means, electronic or mechanical, including photocopy, recordings or any information storage or retrieval system, without permission from the publisher.

Endeavor Business Media, LLC does not assume and hereby disclaims any liability to any person or company for any loss or damage caused by errors or omissions in the material herein, regardless of whether such errors result from negligence, accident or any other cause whatsoever. The views and opinions in the articles herein are not to be taken as official expressions of the publishers, unless so stated. The publishers do not warrant, either expressly or by implication, the factual accuracy of the articles herein, nor do they so warrant any views or opinions offered by the authors of said articles.

Danger approaches fast. Be faster.

MAIN ENTRY LOCKDOWN

Our solution keeps outside threats out with a click of a button, mouse, fob or key switch. Instant lockdown at a fraction of the cost of all-motorized latch retraction—that's the Detex effect.

Call 800-729-3839
detex.com/lockdown28

Request information: www.SecurityInfoWatch.com/10213445

The Medeco logo is displayed in a white, lowercase, sans-serif font against a dark background.The ASSA ABLOY logo is displayed in a white, uppercase, sans-serif font against a dark background.A large, stylized number '4' is positioned in the center of the advertisement. It is rendered in a dark brown color and is superimposed over a background image of a key and a lock cylinder. The key is made of brass and has a serrated edge. The lock cylinder is made of metal and has the words 'medeco' and 'ASSA' engraved on it. The number '4' is the central focus of the advertisement, representing the Medeco 4 key system.

MEDECO 4 High Security Key System

Building on more than 50 years of lock engineering innovation and offering the highest level of protection against physical attack and unauthorized key duplication, Medeco 4 (M4) cylinders are UL 437 Listed with solid brass construction and hardened-steel inserts to thwart drilling attacks. In addition to pins that lift and rotate, M4's design includes 4 side pins: 3 finger pins and 1 lift pin, providing a high level of pick resistance. The patent-pending M4 key design with its movable element protects against the emerging threat of additive manufacturing (3D printing) for superlative credential security.

medeco.com/M4

Experience a safer
and more open world

Request information: www.SecurityInfoWatch.com/10214355



AirAccess Cellular Cloud-Based Access Control from Napco

AirAccess Hosted Access Control from Napco creates new RMR from Alarm Lock Trilogy installations with real-time monitoring.

AirAccess is the first ultra-easy cellular- and cloud-based hosted access system, with unbeatable \$19.95/mo flat rate per system. It is powered by leading StarLink® cellular communications, so it makes the connections for you automatically, without the customers' IT department or network.

Make two-times the RMR with real-time access/alarm monitoring. Just add wireless doors using the number-one rated wireless Alarm Lock Trilogy PIN/Prox Locks (new or retrofits) and/or wireless NetPanel with Wiegand readers or gate operators.

SMBs love the free AirAccess App with built-in mobile credentials; also featuring SMS alerts lockdown. Easy starter kits are available at your local distributor.

For more on AirAccess, visit the links below.

www.airaccess.com



NAPCO
SECURITY TECHNOLOGIES

Request more information: www.securityinfowatch.com/21220927

Introducing the SALTO XS4 Original+



The XS4 Original+ is a universally compatible advanced smart locking system delivering next-generation access control technology in a market proven solution.

Featuring a sleek design, the XS4 Original+ is based on the same proven housing and mechanical mechanisms of the XS4 Original. It can integrate all your physical security needs through wireless networked, easy to install, stand-alone locks giving you real-time access control for virtually all the doors in your building.

The XS4 Original+ solution is suitable for a wide range of customer applications. The broad range of different models and functions provide comprehensive electronic access control to virtually any door.

SALTO BLUEnet real-time functionality and SVN-Flex capability are pre-embedded, enabling SALTO stand-alone smart XS4 Original+ locks to update user credentials directly at the door.

It is compatible with the wide array of SALTO platform solutions, including SALTO Space data-on-card, SALTO KS Keys as a Service cloud-based access solution, and SALTO's Justin Mobile technology for digital keys.

The XS4 Original+ also includes RFID Mifare DESFire, Bluetooth LE, and NFC technology functionality.

The XS4 Original+ also includes RFID Mifare DESFire, Bluetooth LE, and NFC technology functionality.

www.SALTO.us

SALTO
inspired access

Request more information: www.securityinfowatch.com/21245612

Retrofit Exit Devices with SDC

SDC's Quiet DUO™ LR 100 Electric Latch Retraction Kit enables electric access control and dogging of mechanical exit devices. When energized, the motor retracts the exit device latch and pulls the pushpad on most devices into the dogged (depressed) position, enabling momentary or sustained push and pull operation of the door.

It retrofits most major brands of mechanical exit devices, including: Adams Rite, Arrow, Best, Cal-Royal, Corbin Russwin, Design Hardware, Detex, Dorma, Dor-O-Matic, Falcon, Hager, IDC, K2, Jackson, Marks, Marshall Best, PDQ, PHI, Precision, Sargent, Schlage, SDC, Tell, Town Steel, Von Duprin and Yale. Retrofit exit devices with our proven concealed solution.

- Motorized Electric Latch Retraction & Dogging for Fire Rated & Non-Fire Rated Devices
- Retrofits select exit device brands without removing device from door
- Only Latch head cover and end cover plate removable required for most other brands
- Low 700mA Inrush, 200 mA Continuous @ 24VDC
- Quiet Mechanical and Electric Operation
- Eliminates need for costly replacement of existing exit device
- Significantly less labor and costs compared to competitive retrofit kits
- Eliminates need for costly power supplies with high inrush circuitry
- Compatible with UL Listed Access Control Power Supply
- Only 1 Amp SDC brand power supply required for up to 2 exit devices
- Low current enables longer wire runs with smaller gauge wire
- No door sequencers required for pairs of manual doors

For more information, call 1-800-413-8783 or visit the links below.

<http://sdccsecurity.com/LR100-QUIET-DUO-ELR-Kit.htm>

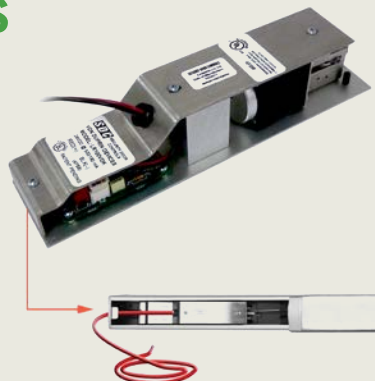

SDC
Security Door Controls

Request more information: www.securityinfowatch.com/10247238

SPECTRE nano Reader from STid

SPECTRE nano, your best agent to secure your parking access, is the most compact UHF and Bluetooth® reader on the market. It improves the user experience while securing and eliminating vehicle access lines.

As the name suggests, the reader is small in size. It is just a bit taller than an average smartphone. Inside its compact but stylish casing, it hosts an innovative and smart combination of technologies.

The multi-technology reader quickly recognizes employees, visitors, vendors, and their vehicles – simultaneously – for smooth, hands-free access control without compromising security. The outside packaging is as rugged and durable as the technology to ensure the reader can stand up to harsh environments – everything from shock, heavy rain, and dust, to salt, frost, and fire (IK10 & IP65 certified).

SPECTRE nano also offers customized branding options to seamlessly fit in at a bus station, corporate office, or private community. The technology is very much suited for use in high-security environments.

<https://stid-security.com>



STid
SPECTRE
NANO

Request more information: www.securityinfowatch.com/21239240

STI No-Touch Stainless Steel IR Switches



The new normal: Touchless access control to reduce the spread of germs. STI's NoTouch® Stainless Steel IR Switch aids in minimizing physical contact and decreases the risk of virus contraction in hospitals, clinics, labs, cleanrooms, schools, department stores, factories, offices or any public building with high traffic areas. To exit/enter a building without touching the door, a user must simply wave their hand in front of the touchless button. The infrared will detect the motion and unlatch the time adjustable door. Constructed of stainless steel, it includes a Form "C" dry contact, 0.5A @120VAC, 1A @24VDC. Integrated adjustable timer 0.5~20 seconds, 12-24 VDC, 45mA (maximum), dual color status LED, 1.5~6 inch detection range. Button available with operating instructions: EXIT, OPEN, or a door symbol.

www.sti-usa.com

Request more information:

www.securityinfowatch.com/21211696



Adams Rite: Narrow Stile Aluminum Solutions

With its 8000 | 3000 Series Exit Devices, Adams Rite offers an exit device for every opening: The most complete line of exit devices and related hardware in the industry; a full suite of mechanical and electrical options and finishes; and secure single pairs of doors with a unified look, standardized installation, and operation. Adams Rite is the aluminum hardware authority, specializing in door and door hardware solutions for narrow stile aluminum applications. From electro-mechanical deadlocks and deadlatches to preload capable electric strikes and electrified exit devices and trim, Adams Rite offers practical and quality code-compliant solutions for retrofitting and upgrading interior and exterior aluminum and glass openings, adding access control to improve the safety and security of your business.

www.adamsrite.com

Request more information:

www.securityinfowatch.com/21220970

Securiton Electromagnetic Locking Solutions



From durable and intelligent to delayed egress and specialty magnets, when you choose a Securiton Magnalock, you get quality solutions for high traffic and high security applications plus our industry leading MagnaCare® lifetime replacement, no-fault, no-questions asked warranty. The new DEM680E Delayed Egress Maglock from Securiton offers the latest in delayed egress technology. For applications meant to prevent peril or property loss to persons and businesses, the maglock is highly configurable and bracket mounted, with 1,200 lbs. holding force. A direct replacement for Securiton IMXDa, the standard model is HUGS-compliant, with other specific code-compliant models also available.

www.securiton.com Request more information: www.securityinfowatch.com/21265065

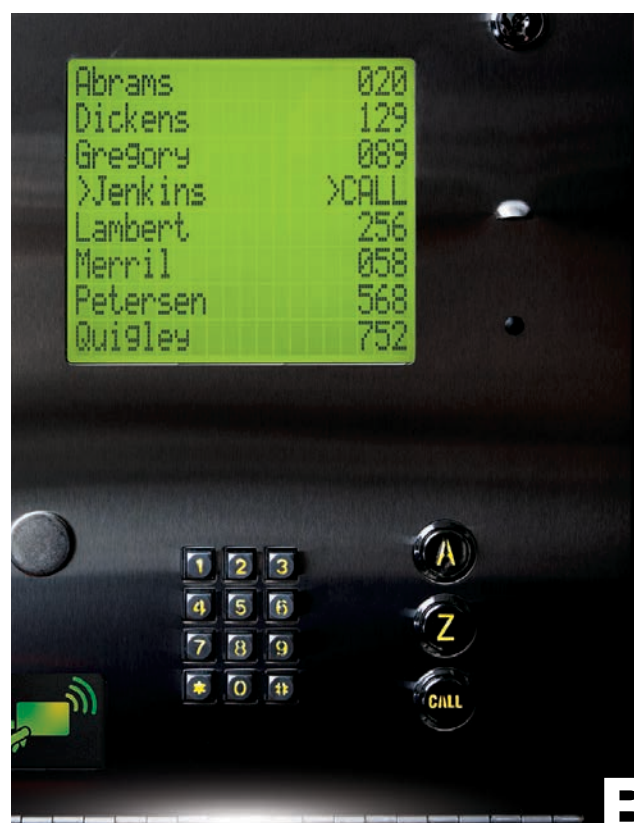

BUILD A TOTAL SOLUTION WITH DKS

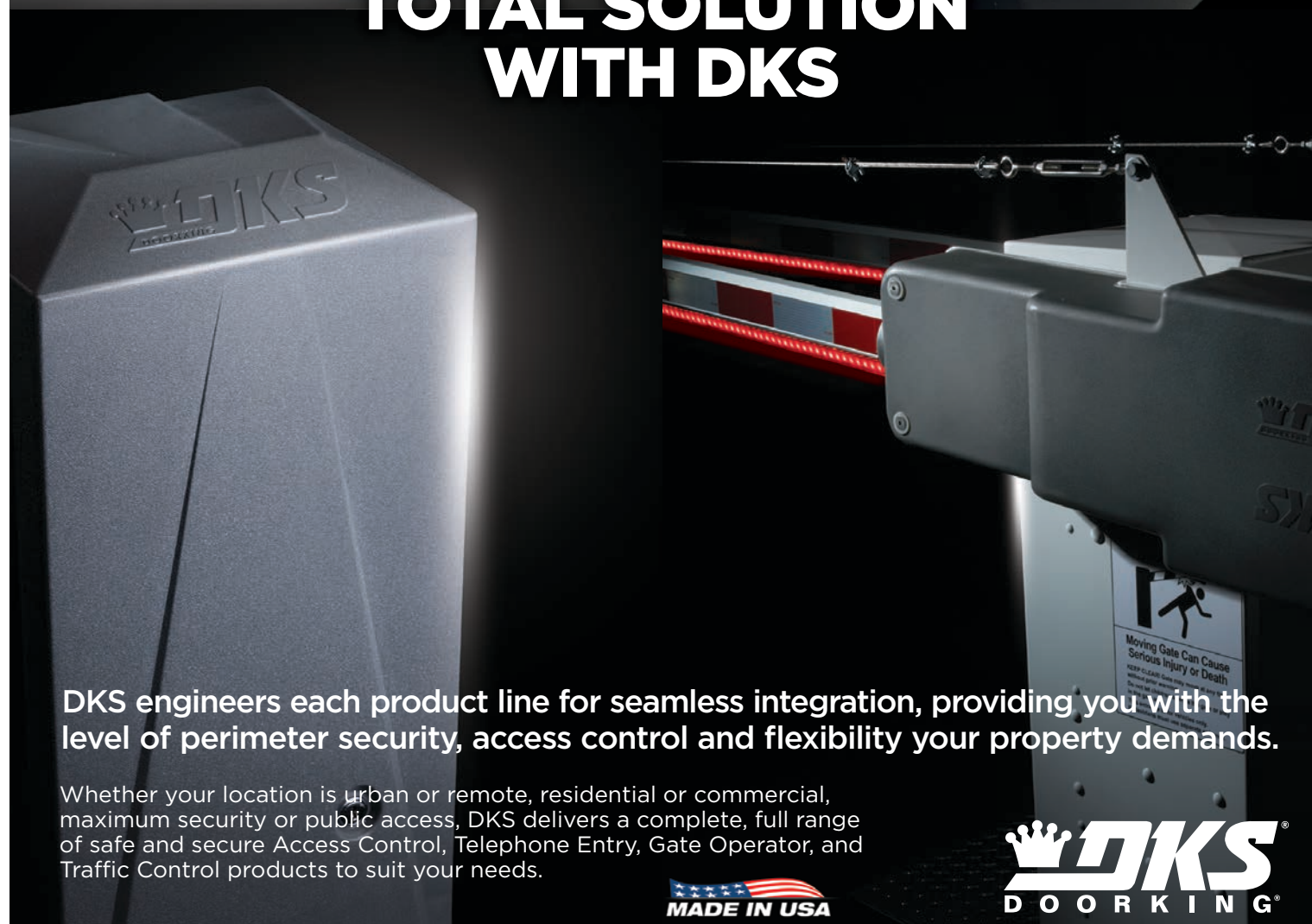

DKS engineers each product line for seamless integration, providing you with the level of perimeter security, access control and flexibility your property demands.

Whether your location is urban or remote, residential or commercial, maximum security or public access, DKS delivers a complete, full range of safe and secure Access Control, Telephone Entry, Gate Operator, and Traffic Control products to suit your needs.

MADE IN USA

DKS
DOOR KING®

Traffic Control | Access Control | Telephone Entry | Gate Operators

Member: AFA, DASMA, NAA, IDA, NOMMA, NPA, SIA, SSA, CANASA

Request information: www.SecurityInfoWatch.com/10213482

FIND YOUR SOLUTION AT:
doorking.com/TotalSolution
800-673-3299 • info@doorking.com



Weatherized Latch Retraction Exit Device from Detex

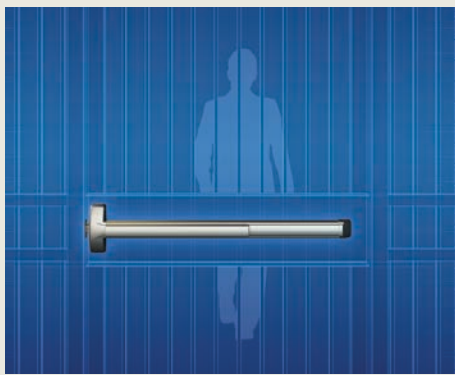

The Detex Advantex Latch Retraction Exit device (ER EX) is now available in a weatherized option. The weatherized latch retraction (ER EX W) exit device is a great option for outdoor access control application where a panic exit device is required.

Perfect for outdoor gates in amusement parks, garden centers, lumber yards, courtyards, and other exterior applications as well as interior applications that get wet, the Advantex Latch Retraction can be configured for single and pairs of doors. Detex also offers gate plates with adjustable strike locators, allowing exit devices to be custom fit to just about any gate application. Detex's Advantex weatherized latch retraction exit device is just the newest addition to the proven list of Detex weatherized door alarms, weatherized exit control locks, weatherized exit devices, weatherized delayed egress and weatherized guard tour products.

For more than a century, Detex has earned the trust of architects and owners who rely on Detex products for the life safety and security of people and property. A USA company, Detex designs, manufactures, markets and ships products from New Braunfels, Texas. Detex Corporation is known internationally for life safety and security door hardware, loss prevention and architectural hardware, integrated door security systems, and guard tour verification.

www.detex.com



Request more information: www.securityinfowatch.com/21265068



Universal Bathroom Privacy Kit (UBPK) from Command Access Technologies

The Universal Bathroom Privacy Kit (UBPK) from Command Access Technologies is an ideal solution for single occupancy restrooms requiring ADA accessibility including privacy and/or security. Built around the NEW LPM193/194 Mortise Lock – the motorized latch retraction and lever control mortise lock – it also includes a power supply, hinge, LED buttons, and auxiliary board.

Command is an electrified locking hardware manufacturer driven by a passion for helping our customers succeed. From answering the phone with a live voice to excellent in-house technical support, we're here from the initial call until your job is successfully completed.

By manufacturing the majority of our products in the U.S., we can promptly respond to any custom or time-sensitive requests and keep a close eye on our quality control – enabling us to offer a Three-year No Hassle Warranty on all of our products.

Remember, on your next project, you'll never lock alone because we are "Always Here to Help!"

www.commandaccess.com



Request more information: www.securityinfowatch.com/21265069

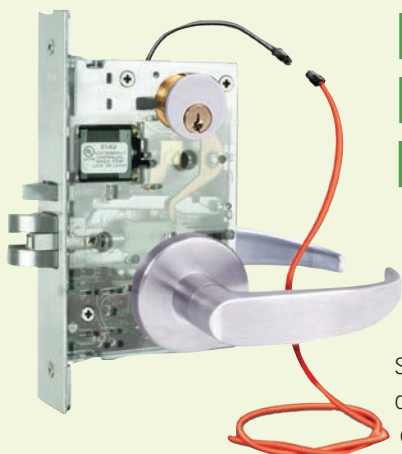

MLR Z7600 Motorized Latch Retraction Mortise Locksets from SDC

SDC's MLR Z7600 Series Mortise Locksets are designed for the access control of openings in commercial, industrial and institutional facilities where code compliance, dependable operation and resistance to physical abuse is required. Ideal for automatic door operator applications, they replace most major brand mechanical locks in new or retrofit applications. MLR Mortise Locksets ensure the door stays latched even when unlocked, perfect for use on fire rated doors to maintain code compliance.

SDC's MLR Z7600 Series Mortise Locksets are designed for the access control of openings in commercial, industrial and institutional facilities where code compliance, dependable operation and resistance to physical abuse is required. Ideal for automatic door operator applications, they replace most major brand mechanical locks in new or retrofit applications. MLR Mortise Locksets ensure the door stays latched even when unlocked, perfect for use on fire rated doors to maintain code compliance.

FEATURES

- Motorized low current operation 620mA inrush, 160 mA holding force @ 24VDC
- SDC Fully Featured Lockset with Complete Application Flexibility for New Construction or Retrofit of Major Brand Mechanical Locks
- New or Retrofit Application, Replaces Most Mechanical Locks
- Field Selectable Handing
- Order with SDC Trim or Less Trim. Compatible with Schlage Trim Provided by Others
- Key Cylinder Latch Retraction
- Full Monitoring Capability (Optional)
- Request-to-Exit, SPDT
- MC-4 Door Contact
- Latchbolt Status, SPDT

Visit the links below or call 1-800-413-8783.

www.sdcsecurity.com/Z7600



Request more information: www.securityinfowatch.com/12400315



SDC S4000 Commercial Exit Device with Factory Installed Latch Retraction

There are many different brands of cost effective commercial exit devices. The majority of them are mechanical only. Today's market demands an Economical Commercial Exit Device with Electric Latch Retraction. Not only does SDC's S4000 Series Electrified Commercial Exit Device satisfy both market needs for a cost-effective exit device with ELR, but the S4000E also comes standard with Request-to-Exit Monitoring, enabling access control compatibility.

The S4000 with pre-installed motorized latch retraction and REX makes application as easy as Install - Power - Done.

- Factory Installed Electric Latch Retraction and REX Monitoring
- Stainless Steel Construction - Corrosion Resistant
- Grade 1 Exit Device
- Compact Design for Commercial & Industrial Applications
- Electric Dogging to Hold the Latch Retracted
- Rim and Surface Vertical Rods
- Trim Options Available
- Hollow Metal, Wood and Mineral Core Door Applications

www.sdcsecurity.com/S4000



Request more information: www.securityinfowatch.com/21220965



Introducing the XS4 Original+

The XS4 Original+ is the next generation of SALTO's most trusted and widely used electronic locks—now including Hardware Secure Element (HSE) technology.

Get the latest security features and advanced capabilities with shorter product delivery lead times.

Learn more at salto.us or call (866) GO SALTO

SALTO
inspired **access**

Request information: www.SecurityInfoWatch.com/10225529



Medeco 4 (M4) Key System

The Medeco 4 (M4) key system enables facilities to have a combination of high-security cylinders and cost-efficient cylinders all on the same key system. It provides patented key control and two levels of protection to ensure the right level of security for each opening in a facility.

M4 High Security cylinders are UL 437 listed for physical strength and high security components, using solid brass construction with strategically placed hardened-steel inserts to prevent drilling attacks. In addition to tumbler pins that lift and rotate, M4's design includes 4 side pins: three finger pins and one lift pin, which must all interact with the sidebar to open, providing a high level of pick resistance. M4 cylinders also meet or exceed BHMA A156.30 criteria for strength and durability, key control, and surreptitious entry resistance.

M4 BiLevel cylinders offer affordable key control through patent-pending keys, without enhanced UL437 attack resistance, which ensures you are not paying for high-security features that may not be needed for certain openings.

The patent-pending M4 key design, with its movable element, also protects against 3D printing for unparalleled security. M4 keys also feature angled, offset cuts on the key blade and unique keyway pre-cuts. A special key cutting machine and access to Medeco-specific blanks are required to duplicate M4 keys, which are available in multiple levels of restriction to support every need.

www.medeco.com/M4



Request more information: www.securityinfowatch.com/21205004

STid Mobile ID Mobile Access Control Solution



STid Mobile ID® simplifies managing and issuing cards by using virtual cards on smartphones, whether or not in combination with conventional cards.

The smartphone, when simply switched on, even during phone calls, becomes an identifier that support 6 unique user interaction modes for instinctive contactless identification to make your access control more intuitive while keeping it secure.

STid offers a complete range of access control readers that are compatible with STid Mobile ID®, including Architect Blue readers and our last SPECTRE nano reader for mixed vehicle & driver identification.

Our access control readers are based upon open contactless identification standards and are designed to support instinctive user interaction.

One of the great possibilities is that you are able to remotely customize, issue or revoke thousands of virtual cards with just one mouse click.

STid Mobile ID® is based on end-to-end security concepts. Both the storage and communication of data take advantage of modern encryption standards.

The flexible and modular design of Architect® readers supports smooth scenarios for existing access control systems to include STid Mobile ID®.

STid Mobile ID® configuration is fast. Deploy STid Mobile ID® today and start using it without delay. Receive a free virtual access card when you install the STid Mobile ID® application on your smartphone.

www.stid-security.com

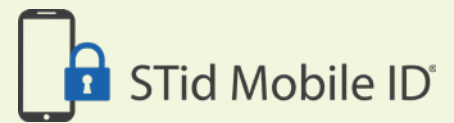

Request more information: www.securityinfowatch.com/12266354

SDC Electrified Z7870/80 Mortise Lockset Hybrid

SDC introduces the Electrified Z7870/80 Mortise Lockset Hybrid with Manual Deadbolt for privacy. Mortise Lockset Hybrids are locked from the outside only and are unlocked by an access control or key from the outside to maintain privacy. Turning the inside lever retracts the deadbolt and latch for uninhibited egress at all times. These fully featured locksets ensure that the door stays latched even when unlocked, maintaining fire door integrity and comply with all national building and fire life safety code requirements for use on fire rated doors.

FEATURES

- SDC Fully Featured Lockset with Complete Application Flexibility for New Construction or Retrofit of Major Brand Mechanical Locks
- New or Retrofit Application, Replaces Most Mechanical Locks
- Field Selectable Handing
- Order with SDC Trim or Less Trim. Compatible with Schlage Trim Provided by Others
- Key Latch Retraction
- Field Selectable Mode (Failsafe/Failsecure) (7830/7832/7850/7852/7835 only)
- Field Selectable Function (7830/7832/7850/7852/7835 only)
- Field Selectable Voltage (7830/7832/7850/7852/7835 only)
- Full Monitoring Capability (Optional):
 - › Request-to-Exit, SPDT
 - › Door Position Status, SPDT (7830/7832/7850/7852/7835 only)
 - › Latched & Locked Status, SPDT (7830/7832/7850/7852/7835 only)
 - › Deadbolt Status (7870/7872/7880/7882 only)
 - › Latch Status (7870/7872/7880/7882 only)

For more details, visit the links below or call 1-800-413-8783.

www.sdcsec.com/MortiseLockHybrid



Request more information: www.securityinfowatch.com/12400308

Alarm Controls: Opening the Door to Affordable Access Control

The new Alarm Controls NTB Series No Touch Sensor utilizes battery-powered, hands-free activation to extend access control for sensitive applications in an easy and affordable way. Now with UL Certification, the NTB Series is a direct replacement for traditional "request to exit" push buttons and can be used to quickly upgrade existing applications to code compliant no touch solutions using existing wiring. Available in multiple stile sizes, finishes and screens to match your opening. Alarm Controls is your one-stop-shop for access control solutions at an exceptional value. Our offering of electro-mechanical products range from maglocks and accessories to push buttons and request to exit stations to specialty products and emergency panic stations. Our custom solutions program specializes in creating unique and versatile designs to meet your specific needs.

www.alarmcontrols.com

Request more information: www.securityinfowatch.com/21257639

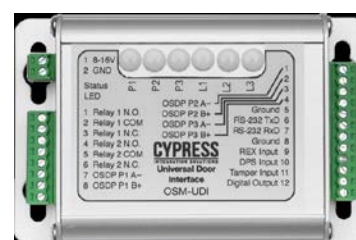

Cypress OSDP Universal Door Interface (OSM-UDI)

The Cypress OSDP Universal Door Interface (OSM-UDI) is used with an OSDP reader and an OSDP panel to control and monitor door hardware through OSDP messages. Using the OSM-UDI means the installer does not need to run cable from each door hardware device back to the access control panel. The unit controls and monitors: Door position sensor, Request to Exit switch (REX), door/gate strike, tamper switch, and other auxiliary functions.

Request more information: www.securityinfowatch.com/21263899



HES Electric Strikes

HES is the leading manufacturer of electric strikes, electric strike accessories and cabinet locks. Known for quality and service, we develop innovative access control solutions and work to earn long-term relationships with distributors and installers, all based on the goal of delighting our valued customers. We have Versatile and durable electric strikes for cylindrical and mortise locks, and rim exits for every type of lock-set, including outdoor rated products for perimeter doors that are UL 1034 listed, suitable for outdoor use.

<http://hesinnovations.com>

Request more information:

www.securityinfowatch.com/10213861

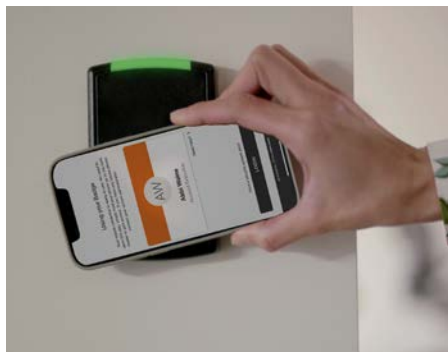

Alarm.com Access Control Readers and Mobile Access Credentials

Alarm.com has released three new access control readers, featuring support for encrypted credentials, as well as mobile access credentials for even greater convenience. With the new readers, users can use their smartphones to unlock doors instead of using a separate badge or key fob. Using mobile credentials saves time, money, and frustration by eliminating the need to manage separate physical credentials, which are easier to misplace or steal. Available in mullion, single gang, and keypad form factors, each reader also supports both proximity and EV2 smart credentials.

Request more information:

www.securityinfowatch.com/21265086

CV-603 Two-Door Bluetooth Access Control from Camden

Camden has upgraded its industry-leading CV-603 BLE two-door access control system with virtual credentials. This advanced system now comes ready to support each system user with the credential of their choice, whether it be a mobile Apple® or Android® smartphone credential, a prox card/tag, or two button wireless key FOB. Best of all, the system does not require an additional wireless receiver or Bluetooth® module - and there are no subscription fees! The CV-603 series (MProX BLE) is an app-based wireless Bluetooth® managed access control system, designed to provide 'best in class' security of doors and gates. The CV-603 can accommodate up to 2,000 users.

www.camdencontrols.com/promo603SIW

Request more information: www.securityinfowatch.com/21221169



LPM190 SERIES

SMOOTH, QUIET, STRONG

MOTORIZED LATCH RETRACTION

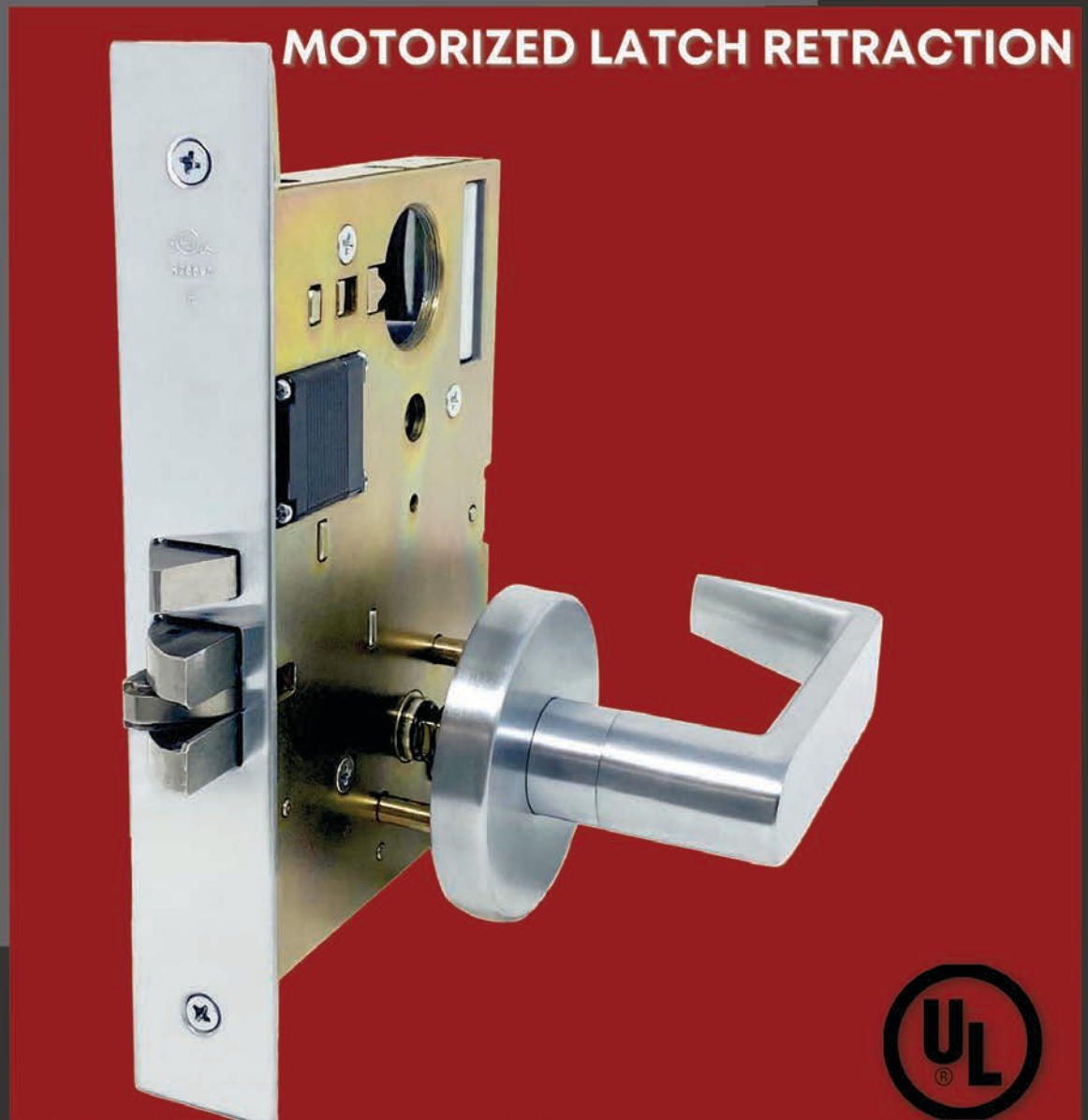

Request information: www.SecurityInfoWatch.com/12140374



LEARN MORE

NO HASSLE
3 YEAR
WARRANTY

P. 888.622.2377

COMMANDACCESS.COM

Trine's 4850ITL Electric Strike Installation Tool

Trine Access Technology has developed the ultimate tool for installing electric strikes used with rim panic devices. As with all Axion strikes from Trine, this tool was designed to install the entire 4800 series line of strikes quickly and accurately the first time making the best installation available today.

The 4850ITL is not just a template, it is made from actual production parts, giving the installer the ability to adjust for common door issues such as sagging and misalignment. By placing the ITL on the frame, it allows the installer to "feel" the strike working with the door and panic device allowing for fine adjustments before holes are drilled.

The flexibility and therefore accuracy of the 4850-ITL is derived from our patent pending magnetic holding system built into the body of the tool.

Combine this with a custom center punch that is included with every 4850-ITL used to make perfectly centered marks on the frame, this tool is a must for every installer of electric strikes. See the video by searching "4850ITL" on YouTube!

www.trineonline.com

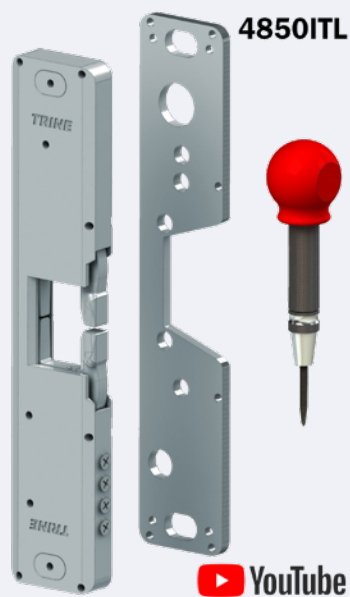

Request more information: www.securityinfowatch.com/11416079

ANSI-ITL for the Best and Easiest Installation of Trine Electric Strikes

Trine's ANSI-ITL is the best way to install both 4-7/8" and 2-3/4" Trine Electric Strikes. Lean and efficient, it utilizes only two pieces each (screwed together) for the 4-7/8" and 2-3/4" cutouts, which means fewer lost parts. The Installation tool can be used with the 4100, 4100DBDL, 4200, EN400, EN435, EN430 electric strikes as well as 478, 478X, 234, and 234X installations on the 3000 series. Adjustments on the installation tool allow for installation even on the lower cutout of the Schlage L series – for use with the 4100 and 4100 DBDL. Additionally, the tool includes a scribe pen for accurately marking the cut-out lines on the frame. Two mounting screws for the tool is also included.

Please note the ANSI-ITL replaces the older 478-ANSI-ITL model number.

The ANSI-ITL is fast, easy, and accurate. Ask your distributor how you can get yours today.

www.trineonline.com



Request more information: www.securityinfowatch.com/12385102



PERIMETER SECURITY

DoorKing Model 1620 Lane Barrier System

The DoorKing Model 1620 Lane Barrier System is ideal in applications where a higher degree of vehicle traffic control is desired, but without the expense of deep excavation that is typically required for the installation of bollards, wedges or crash beams.

The 1620 can be surface mounted, making in an ideal choice for installation in multi-level parking garages, apartment communities, gated condominiums, parking lots and toll booths. The lane barrier uses a simple counter-balanced mechanical linkage to the companion 1603-580 operator. This counter-balanced system eliminates the need for hydraulics making the system environmentally friendly.

The system is fast acting, raising the steel barrier in approximately 2.5 seconds. LEDs and a signal light remain red until the steel barrier is in the full down position and the signal arm is in the full up position, at which time the LEDs turn to green for safe passage.

The barrier system consist of heavy-duty steel anchorages mounted on each side of the traffic lane and a steel barrier with a nylon strap rated at 22,000 lbs. holding force imbedded within it. This Lane Barrier System is not crash rated. It is intended to provide a formidable barrier to help prevent passenger vehicles and light-duty trucks from driving through a controlled traffic lane at speeds up to 20 mph.

www.doorking.com/traffic-control/1620-lane-barrier



Request more information: www.securityinfowatch.com/21265080

DSC550 16-Foot Open Frame Vehicle Barrier from Delta Scientific

Delta Scientific has successfully tested a 16-foot version of its DSC550 shallow foundation open frame barrier to the new ASTM F2656-20 standard, which measures the penetration level from the leading edge of the barrier vs. the back-side of the barrier like the previous standard. The barrier features a shallow foundation of only 24 inches (61 cm), which alleviates the concerns of interference with buried pipes, power lines and fiber optic communication lines in urban applications. The unit provides an emergency fast operation of 1.5 seconds for electro-mechanical and 0.75 seconds for hydraulic operations. This allows a guard to quickly react to a threat.

Request more information: www.securityinfowatch.com/21254571



PureActiv C4ISR Perimeter Protection System from PureTech Systems

PureTech has integrated short and long-range Counter UAS capabilities into its Autonomous Geospatial Border and Perimeter Protection system. At a testing range similar to a typical border operational environment, the PureActiv C4ISR was able to detect and track small UAS flying different evading trajectories within the range of deployed sensors that included 3D radars from SRC and Echodyne, long-range EO/IR cameras from PVP, and a Whisper Hunter direction finder from SRC. Simultaneously, using its artificial intelligence and machine learning algorithms, PureActiv was able to autonomously detect, track, and identify people walking, thus providing increased situational awareness for the operators.

Request more information: www.securityinfowatch.com/21262110



Proud Distributor of dormakaba Touch-Free Solutions

IDN is your source
for dormakaba
products

dormakaba 



Contact your local IDN to place an order or for a quote



WE MAKE SECURITY SIMPLE

www.idn-inc.com

OVER 50 LOCATIONS IN THE U.S. AND CANADA



Theia Technologies' Award-Winning 4K Lens Family

Theia's family of 4K lenses provides full 12 megapixel 300 lp/mm resolution performance for the most demanding applications such as ANPR/LPR, traffic monitoring and analytics.

Two lenses cover a horizontal field of view of 7 to 112 degrees, with the SL/TL410 lens providing a 4-10mm focal range, while the SL/TL1250 telephoto lens offers a 12-50mm focal range. Both have excellent IR correction with less than a 5µ focus shift in Near IR light for superior Day/Night performance. At f/1.4 the SL/TL410 lens offers excellent light gathering ability in low light conditions. The lenses are designed to cover the larger 1/1.7" 4K image sensors while at the same time resolving the smaller 1.55µ pixels of the 1/2.3" 4K sensors.

Measuring only 52mm long (64.5mm TTL) they are the most compact of comparable 1/1.7" format 4K lenses available on the market to facilitate use in domes, bullets, small enclosures, as well as on box cameras. Both lenses feature a slip ring mount that allows the user to position thumb screws for convenient access to focus and focal length adjustments post-installation on the camera.

The lenses are offered in manual, DC Auto, or Precise iris versions, and CS or C mount depending on the model.

For full specifications, drawings and CAD files, visit the links below, or email info@theiatech.com for pricing and availability.

www.theiatech.com/4k-resolution-lenses



Request more information: www.securityinfowatch.com/12399899

Ava Quad Multi-Sensor Surveillance Camera

The Ava Quad cloud-native multi-sensor security camera expands the company's suite of cloud-connected video monitoring tools. This security camera is designed to provide 360° visibility, and is advantageous for customers looking for multi-angle coverage over wide outdoor or indoor areas. Customers will benefit from easier access to security data and in-built video and audio analytics, reducing costs for organizations by cutting the time and staff needed to analyze footage. It connects to Ava's data platform improving response to incidents with machine learning algorithms to identify critical events before they escalate.

Request more information: www.securityinfowatch.com/21257399



i-PRO U-Series IP Cameras

i-PRO Americas Inc's new U-series models include a selection of vandal- and weather-resistant outdoor and indoor pan/tilt/zoom (PTZ) cameras with 2MP resolution. Three new U-series PTZ outdoor vandal- and weather-resistant PTZ cameras and three indoor PTZ cameras are available with a selection of 21X, 10X and 3.1X (optical) zoom capabilities, while one of the new outdoor PTZ cameras is available in a compact form factor. Additional features include: H.265 compression and smart coding to increase bandwidth efficiency and reduce storage requirements, color night vision for use in low-light conditions, and intelligent auto with super dynamic functions for enhanced dynamic range in scenes with varying lighting conditions.

Request more information: www.securityinfowatch.com/21261633



Linear Surveillance Line from Nice/Nortek Control

Nice/Nortek Control demonstrated its new Linear Surveillance line at ISC West 2022. This multi-family line of intelligent AI powered cameras and NVR are designed to seamlessly integrate with Linear Access Control & Telephone Entry systems. The line features the new Linear 8 and 16 channel NVRs and the advanced, IV400 Intelligent AI cameras, powered by IntelliVision analytics. A more cost-effective solution is the IV200 2MP camera. Each product within the line completes the quest for a more unified AI-powered surveillance and access ecosystem.

Request more information: www.securityinfowatch.com/21257643



Prevent the Spread of Germs

JUST WAVE TO ENTER!

- | | | |
|-------------------------------|------------------------------------|--------------------------------------|
| NoTouch® infrared wave action | Adjustable relay latch 0.5~20 sec. | Simply open a door with wave of hand |
| Four touch free sizes | Dual color state LED | Detection range 1.5 ~ 6" |



Safety Technology International

www.sti-usa.com/sd104 | 248-673-9898

2022

TOUCH-FREE IR SWITCHES



Request information: www.SecurityInfoWatch.com/10214881

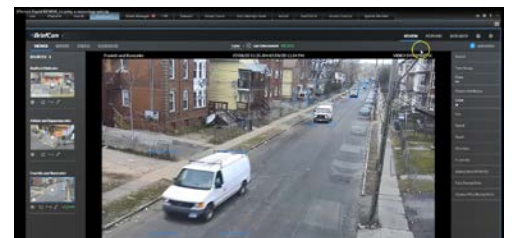

Milestone XProtect Rapid REVIEW

Milestone's XProtect Rapid REVIEW is an intelligent video analytics solution that allows security operators and investigators to efficiently search through hours and hours of video recordings and pinpoint exactly what they are looking for in minutes. Powered by BriefCam video analytics technology, the add-on product is seamlessly integrated into Milestone's XProtect Smart Client and enables highly accurate, cross-camera video searches and filtering, based on an expanding suite of classes, attributes, behaviors and visual layers that help investigators pinpoint people, objects, and behaviors of interest.

Request more information: www.securityinfowatch.com/21257397

PLUG & PLAY ACCESS POWER

4PPoE Driven Power – by ALTRONIX

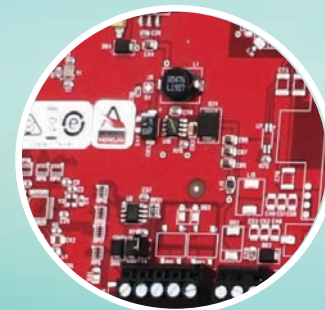
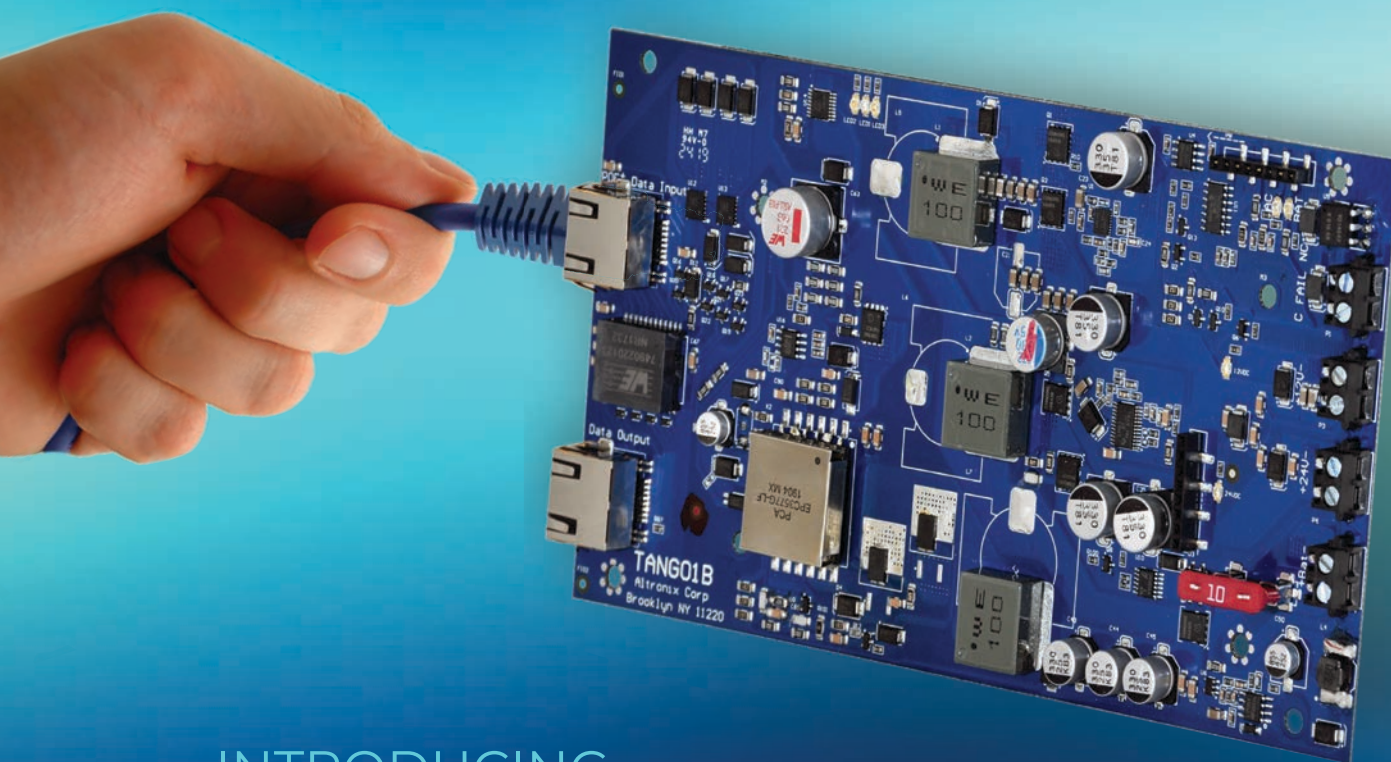

Power for 12 & 24VDC
controllers, devices,
and peripherals



INTRODUCING
TANGO

Tango power supply/chargers provide faster, safer deployments, eliminating high-voltage by utilizing 802.3bt PoE.

- Converts PoE to 12VDC and 24VDC simultaneously
- Power your access system from a single cable, reducing costs and increasing profits
- Built-in LiFePO4 battery charger

 | Altronix®

YOUR LEADER IN POWER SOLUTIONS

Request information: www.SecurityInfoWatch.com/10212790



Altronix Trove3MBK3 High-Capacity Access and Power Solution

The new Trove3MBK3 high-capacity Access and Power solution from Altronix increases capacity to accommodate more Mercury access control hardware allowing up to 36-doors without power and 24-doors with Altronix power in a single enclosure. This saves valuable space while making system configuration faster and easier. TROVE3MBK3 includes a Trove3 enclosure with TMB3 Backplane along with 36-BR3M angled mounting brackets for power distribution and controllers. TMB3 backplane also supports DIN Rail mounting for customized applications. Optional side wiring and battery enclosures are also available to further streamline deployment.

www.altronix.com/products/Trove3MBK3

Request more information: www.securityinfowatch.com/21257729



Fiber-Enabled Network Switch from TechLogix

The TechLogix TL-NS42-POE provides Gigabit ethernet switching via four twisted pair ports, one fiber SFP port, and one SFP/RJ45 combo port. It is ideal for long network runs and merging copper and fiber optic network equipment. In addition to residential and commercial data networking, the unit also supports several features required for security and access control. All twisted pair ports support 30W PoE and 12KV surge protection, and redundant power inputs with reverse power protection allow for local or remote power. It supports multimode or single mode fiber when paired with corresponding SFP transceivers modules.

Request more information:

www.securityinfowatch.com/21265098



ProdataKey PoE++ Module Kit

ProdataKey's PoE++ Module Kit is an expansion module that equips any pdk Red high-security door controller with PoE connectivity for communication and full power. When plugged into the controller's board, the module powers the board itself and all the electrified hardware connected to it. The result is simplified installation and reduced cable runs that deliver savings on both labor and materials. The PoE++ Module can operate in extreme temperatures and up to 95% relative humidity, making it appropriate for use in almost any location where controllers are mounted.

Request more information:

www.securityinfowatch.com/21265096

TOUCH-FREE CALLING



Goodbye germs, hello hands-free!

These Touch-Free VoIP Entry Phones are equipped with Viking's touchless motion sensor. A simple wave over the sensor will activate a call. Touch-free calling eliminates the exposure to germs and bacteria from typical push button switches.

The phones provide quick and reliable handsfree communication for SIP VoIP phone systems with PoE. They can be programmed from any touch tone phone, PC, or remotely using a static IP address.



Learn more about
**TOUCH-FREE
CALLING**

VIKING

DESIGNED
MANUFACTURED
& SUPPORTED
USA

Start planning your installation!

715.386.8861

vikingelectronics.com

Request information: www.SecurityInfoWatch.com/10556843

If your **PROJECT**
HINGES *on*
SPEED

we'll
HANDLE *it.*



No matter what your project hinges on, we can handle it.

From complex projects to repeat orders, we'll find the right solution for you so you can focus on what's truly important: driving your business forward.



bannersolutions.com

Request information: www.SecurityInfoWatch.com/12071932



Viking Electronics Touch-Free VoIP Entry Phones

Viking's Touch-Free IP Entry Phones feature a built-in motion sensor. Simply wave your hand over the sensor to place a call. The no-contact operation eliminates exposure to germs and bacteria from typical push buttons, while providing quick and reliable communication for SIP VoIP phone systems with PoE. For visibility, the sensor LED lights blue when idle, flashes green while calling, and lights solid green when the call is answered. These entry phones dial up to five different numbers and can be programmed from any touch tone phone, PC, or remotely using a static IP address. On-board 2 Amp relay contacts are provided for activating door strikes or gate controllers. Flush and surface mount options are available, as well as Enhanced Weather Protection for outdoor installations.

<https://vikingelectronics.com/products/e-30tf-ip> Request more information: www.securityinfowatch.com/21241961



Commend's Concerto Communication Terminals

Commend's Concerto line, the latest generation of security and communication terminals, helps security managers design, manage, and administer their own concert of security and efficiency. With Commend Concerto, strategic communication points can be combined to form a perfectly coordinated communications infrastructure, based on specific needs. Concerto solutions are designed



to meet the evolving and complex needs of the enterprise, until now. Introducing the OD1, an outdoor intercom terminal that provides unified communication and security by delivering technology designed to meet middle market and SMB requirements. OD1 makes the Concerto technology accessible for a new market of customers.

Request more information: www.securityinfowatch.com/21257344

YOU ASKED. WE LISTENED!

CX-ED1500 SERIES ELECTRIC STRIKES

FOR MORTISE & CYLINDRICAL LOCKSETS

You asked us for a new mortise strike that combines the high quality of European brands with a new level of flexibility performance and value. We answered with our new 1500 Series dual monitor and low profile strikes!

PACKAGE SELECTION

- **CX-ED1500-L2-Pac-1**
Dual Monitor Strike, 8 Faceplates
- **CX-ED1500-L2-Pac-2**
Dual Monitor Strike, 4 Faceplates for Latchbolts
- **CX-ED1500-L2-Pac-3**
Dual Monitor Strike, 4 Faceplates for Deadbolts
- **CX-ED1500-LP-Pac-1**
Low Profile Strike, 4 Faceplates for Latchbolts



CX-ED1500-L2
Dual Monitor

CX-ED1500-LP
Low Profile

Multiple
Faceplate
Packages



TPU600-G2 Paging Amplifier from Bogen Communications

The TPU600-G2 from Bogen Communications is a high-powered, Class D amplifier designed for telephone paging applications. Featuring a new hardware design, it boasts a small footprint and lightweight design with both wall-mount and rack-mount capabilities. The new model incorporates next-generation technologies and future-proof design concepts such as a high-power, 600W Class D amplifier that provides higher efficiency amplification with traditional low-noise characteristics, decreased weight and lower heat dissipation. The paging channel features automatic output leveling (ALC) as channel input varies, which is particularly important in telephone paging applications.

Request more information: www.securityinfowatch.com/21265102

AUTO ENTRYCONTROL™

For Automatic Profits



Built-in 1 Amp+ Power Supply provides the ability to power electric latch retraction without a separate power supply.

SDC's Auto EntryControl™ Low Energy Swing Door Operator has the best warranty and lowest price of any competitive low-energy brand in the industry. The design **saves installation time** and helps **meet all US and Canadian ADA requirements** for door installation in retail storefronts, office buildings, campuses and healthcare facilities.

Built-in, 1 Amp+ 24 VDC Power Supply

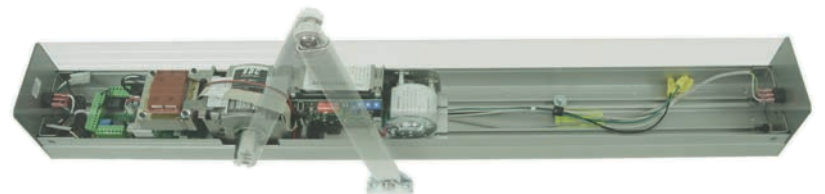

- For Low-Power Retrofits of any Building Entrance with an Exit Device
- Integrates easily with popular Access & Egress Control Hardware

Easy, One-man Installation

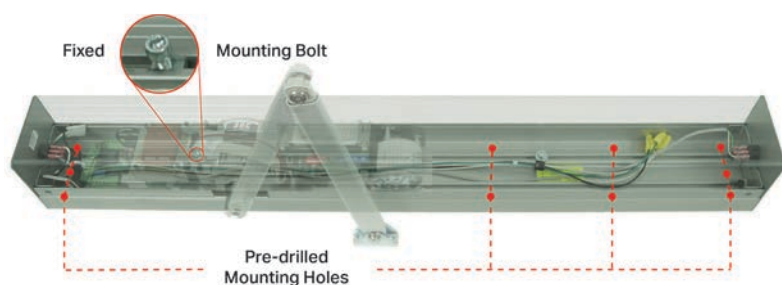

- Single Button Setup, Self-Tuning, Self-Learning
- Onboard Lock Sequencing

Perfect for use with SDC's Quiet DUO™ LR100 Series Electric Latch Retraction Kits

- Retrofits most brands of mechanical exit devices
- Low 700mA Inrush, 200 mA Continuous

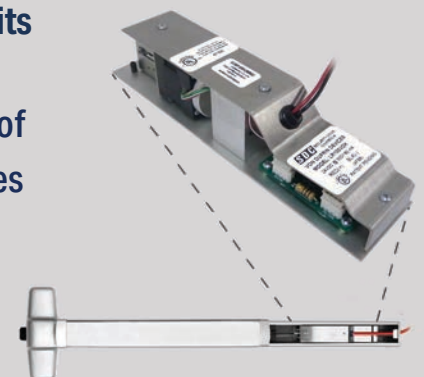

www.sdcsec.com/LR100series

www.sdcsec.com/AUTOoperator

Request information: www.SecurityInfoWatch.com/10214991



the lock behind the system

sdcsecurity.com ■ 800.413.8783

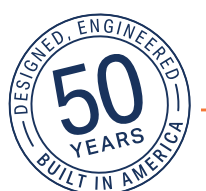



You're the best at what you do. So are we.

When it comes to sourcing the right parts for the job—any job—no one comes close to SECLOCK. Our team of technical service reps is unrivalled in the industry, meaning you get exactly what you need exactly when you need it, every time.

You have other things to worry about. Let us take care of the hardware.

Visit SECLOCK.com to see how we can help.

dormakaba 

BEST 

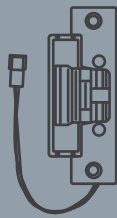

info@SECLOCK.com

800.847.5625